

SHEET1

Rev:	Date:	By	Chk	Description
A.1	9/18/12	PJE	RAW	EC0 0045
A.2	10/06/12	JWW	PJE	EC0 0192

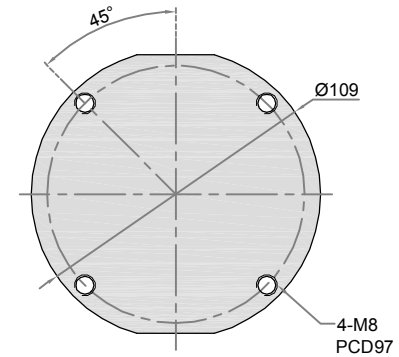
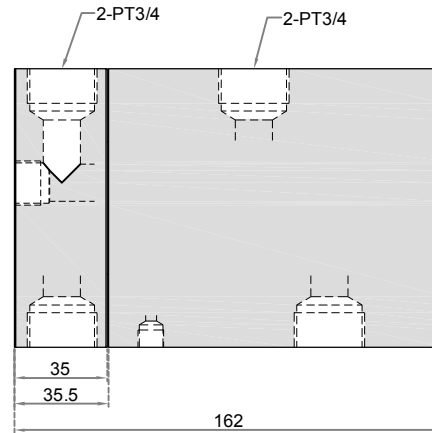
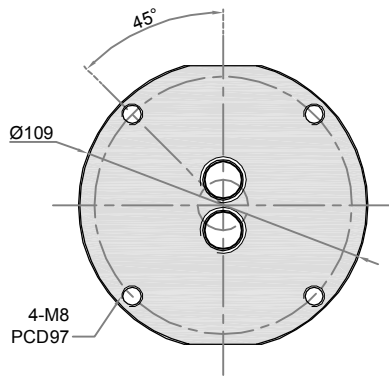

技术参数：
 最高转速：300RPM
 最高温度：185°C
 最大压力：350BAR
 介质：液压油 水

Drawn	JSM	6/2/03
Checked	PJE	13/43/05
Checked	PJE	11/36/08

TOLERANCE
 EXCEPT AS NOTED
 x.x ±.125
 x.xx ± 0.15
 x.xxx ± 0.005
 ANGLES ± 0.5°

HIDNEY

深圳市欣德利机电设备有限公司

TEL:0755-27222664

CUSTOMER APPROVAL/DATE:

SHAFT MEL/PLTING:

CARBON STL
 94-62 RC
 BLK OXIDE

CUSTOMER:

STOCK

THIS DOCUMENT CONTAINS INFORMATION WHICH IS PROPRIETARY TO DYNAMIC SEALING TECHNOLOGIES.INS (HIDENY) NO REPRODUCTION OR PUBLICATION OF THIS DOCUMENT OR IT IS CONTENTS,IN SHOLE OR PART SHALL BE MADE WITHOUT THE WRITTEN CONSENT FROM HIDNEY

SHAFT MEL/PLTING:

CARBON STL
 BLK OXIDE

P/N:

REV:

A 4

THIRD ANGLE PROJECTION:

